

Clip

PART #: SJ 2011 00053 101

KEY FEATURES

- 3.26L x 1.15W x 2.60H mm
- Forward contact
- Side protected

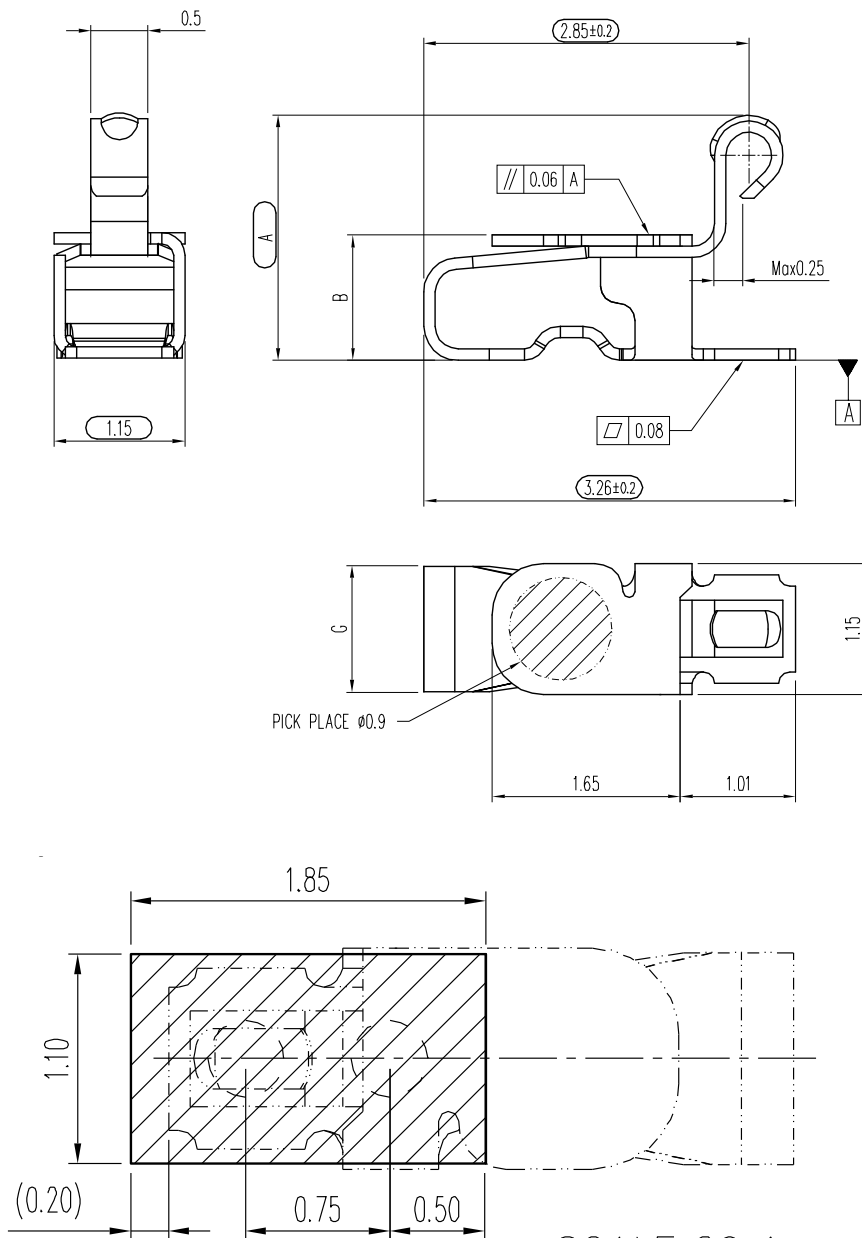

SCALE 20:1